

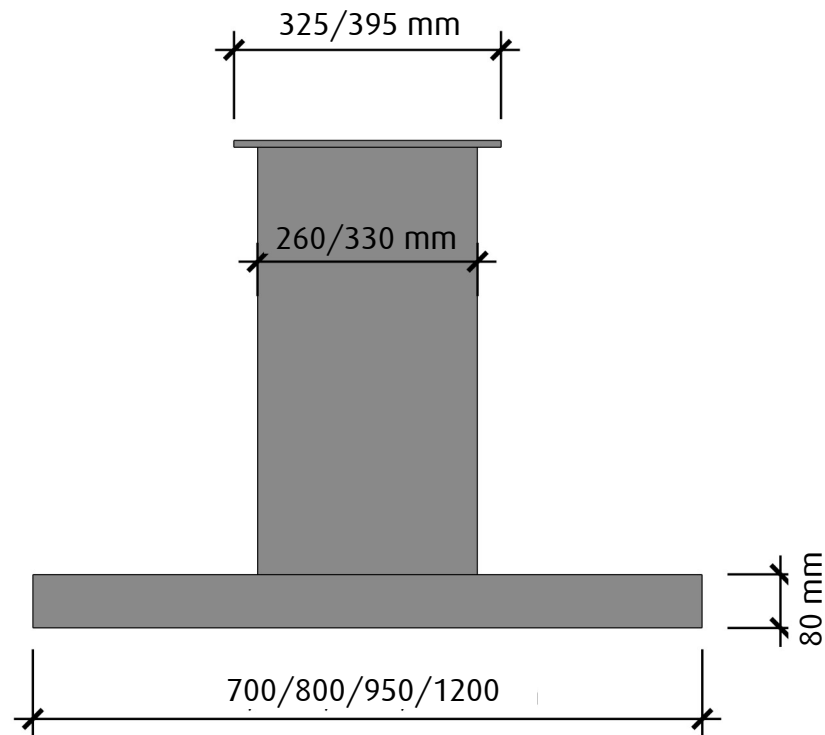

## FRAMSIDA

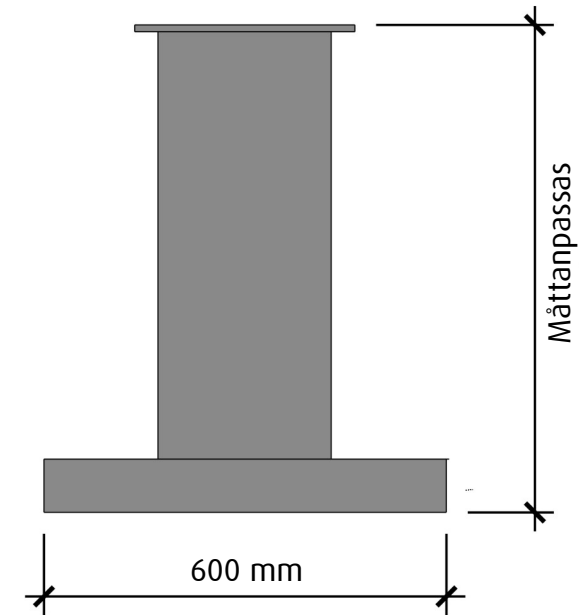

## HÖGERSIDA

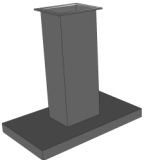

Vid 95 cm bred kupa eller bredare är skorstenen 330 mm bred

 <b>fjäråskupan</b>	MÅTTSKISS	TYP	STIL	LANSERAD	SIDA	
	<b>PLAN</b>	<b>FIRHÄNGANDE</b>	<b>MINIMALISTISK</b>	<b>2016</b>	<b>1 (2)</b>	

## OVANSIDA

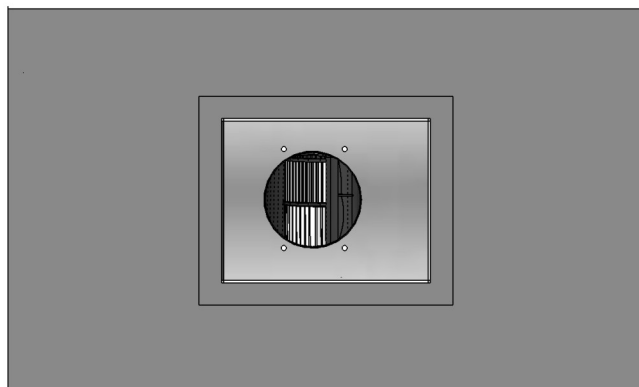

## UNDERSIDA

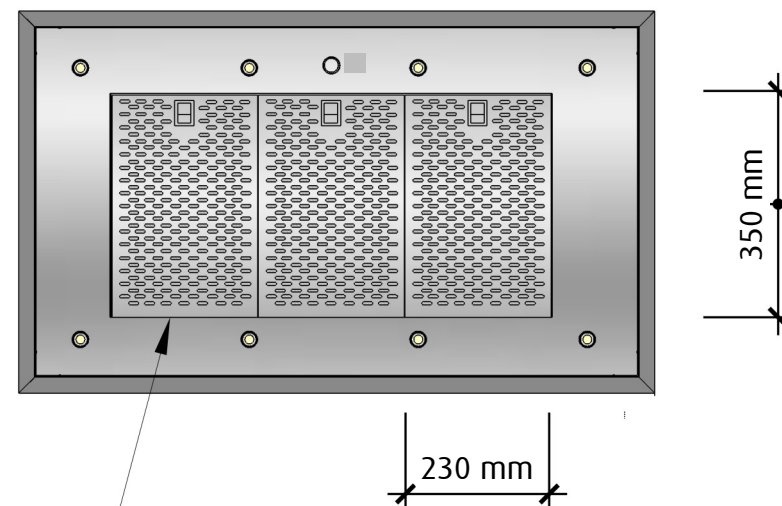

Undersidan är upphöjd ca. 4 cm i kupan  
för bättre osupptagning

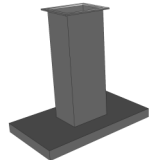
 <b>fjäråskupan</b>	MÅTTSKISS	TYP	STIL	LANSERAD	SIDA	
	<b>PLAN</b>	FRIHÄNGANDE	MINIMALISTISK	2016	2 (2)	