

FRAMSIDA/FORSIDE/ETUOSA/FRONT

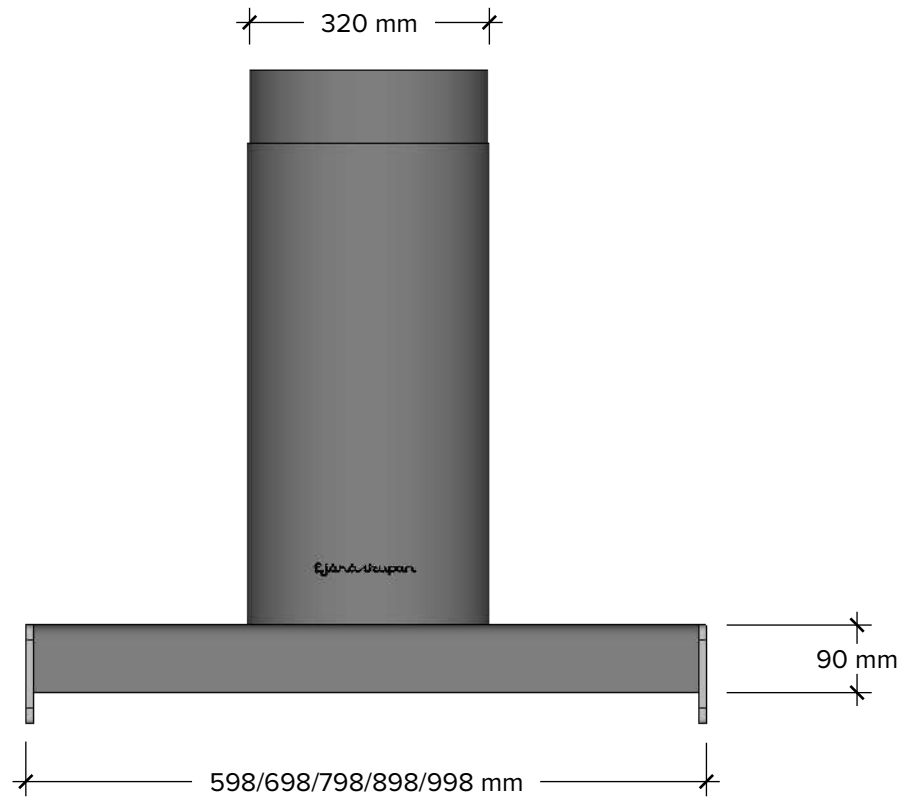

HÖGERSIDA/HØYRE SIDE/OIKEALLA/RIGHT SIDE

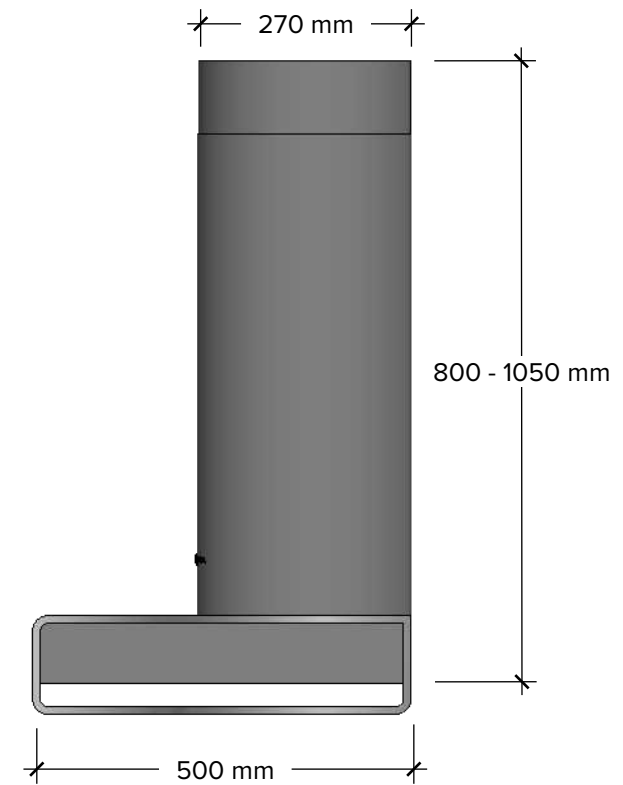

OVANSIDA/TOPP/YLÄKOTELOSSA/TOP

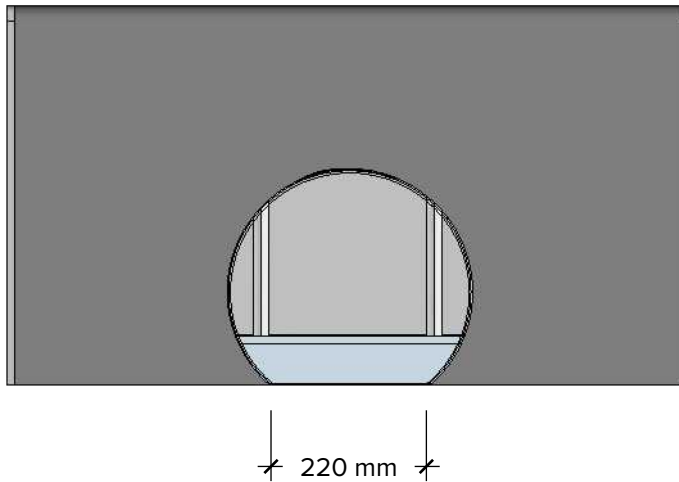

UNDERSIDA/UNDERSIDE/POHJAAN/UNDERSIDE

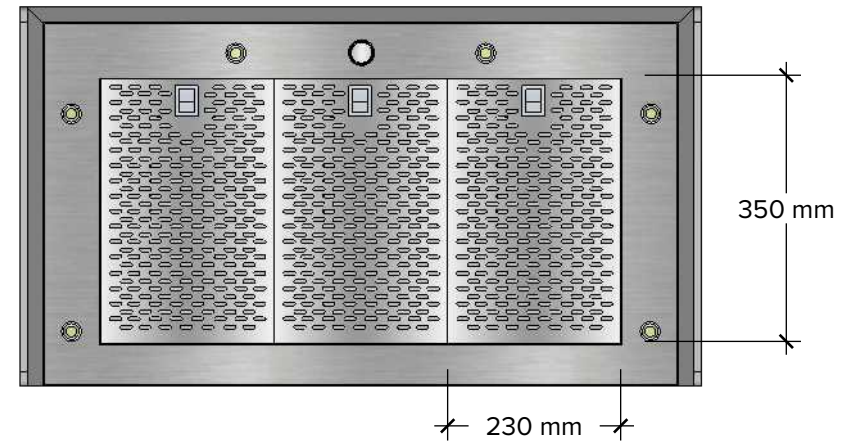

Undersidan är upphöjd ca. 4 cm i kupan för bättre osupptagning
 Undersiden er hevet ca. 4 cm i viften for bedre bsorpsjon
 Alaosa on kohotettu n. 4 cm pesässä parempaan imeytymiseen
 The underside is raised approx. 4 cm in the kitchen fan for better absorption